

Revisiting Differential-Linear Attacks via a Boomerang Perspective

Applications to AES, Ascon, CLEFIA, SKINNY, PRESENT, KNOT, TWINE, WARP, LBlock, Simeck, and SERPENT

Hosein Hadipour Patrick Derbez Maria Eichlseder

ASK 2024 - Kolkata, India



Research Gap and Our Contributions



Research Gap

- 🕒 How to analytically estimate the correlation of DL distinguishers?
- 🕒 How to (efficiently) find good DL distinguishers?



Contributions

- 🕒 Generalizing the DLCT framework [Bar+19] for analytical correlation estimation.
- 🕒 Introducing an efficient method to search for DL distinguishers applicable to:
 - Strongly aligned SPN primitives: AES, SKINNY
 - Weakly aligned SPN primitives: Ascon, SERPENT, KNOT, PRESENT
 - Feistel structures: CLEFIA, TWINE, LBlock, LBlock-s, WARP
 - AndRX designs: Simeck

Research Gap and Our Contributions



Research Gap

- ✔ How to analytically estimate the correlation of DL distinguishers?
- ✔ How to (efficiently) find good DL distinguishers?



Contributions

- ✔ Generalizing the DLCT framework [Bar+19] for analytical correlation estimation.
- ✔ Introducing an efficient method to search for DL distinguishers applicable to:
 - Strongly aligned SPN primitives: AES, SKINNY
 - Weakly aligned SPN primitives: Ascon, SERPENT, KNOT, PRESENT
 - Feistel structures: CLEFIA, TWINE, LBlock, LBlock-s, WARP
 - AndRX designs: Simeck

Outline

- 1 Background
- 2 Generalized DLCT Framework
- 3 Differential-Linear Switches and Deterministic Trails
- 4 Automatic Tools to Search for DL Distinguishers
- 5 Contributions and Future Works

Background



Universal Bound for Data Complexity - I

Theorem (Data Complexity)

Let X_0 and X_1 be two distributions. Given one sample from X_b , the distinguisher \mathcal{D} outputs 1 with probability p if $b = 0$, and outputs 1 with probability q if $b = 1$. Assume that b is chosen uniformly at random from $\{0, 1\}$ and is fixed. Next, we run \mathcal{D} on n samples, and output 1 if the sum of the outcomes is closer to $\mu_0 = np$, and 0 otherwise. If n satisfies the following inequality, then the error probability of the distinguisher is upper bounded by ε :

$$n \geq \max \left(\frac{2(3q + p) \ln \left(\frac{1}{\varepsilon} \right)}{(p - q)^2}, \frac{8p \ln \left(\frac{1}{\varepsilon} \right)}{(p - q)^2} \right).$$

Universal Bound for Data Complexity - II

- $$n \geq \max \left(\frac{2(3q+p) \ln\left(\frac{1}{\epsilon}\right)}{(p-q)^2}, \frac{8p \ln\left(\frac{1}{\epsilon}\right)}{(p-q)^2} \right).$$
- If $p \gg q$, then $p - q \approx p$ then $n \geq \frac{8 \ln\left(\frac{1}{\epsilon}\right)}{p}$.
- If $p = \frac{1}{2} + \frac{c}{2}$, $q = \frac{1}{2} + \frac{c'}{2}$, $c \gg c'$,
 and $c, c' \ll \frac{1}{2}$ then $n \geq \frac{8 \ln\left(\frac{1}{\epsilon}\right)}{c^2}$.

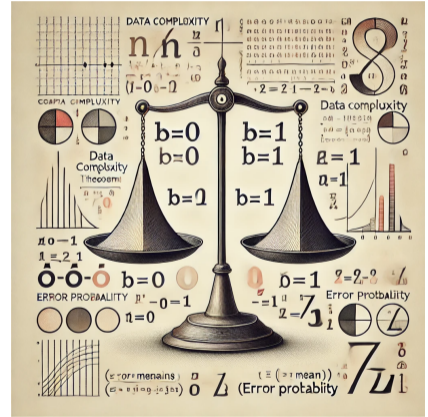

Generated using OpenAI's DALL-E.

Differential Attacks [BS90]

Input: $E_K, (\Delta_i, \Delta_o), N, p = \mathbb{P}(\Delta_i, \Delta_o)$

Output: 0: **real** cipher, 1: **ideal** cipher

```
1 Initialize counter  $T$  with zero;
2 for  $i = 0, \dots, N - 1$  do
3    $P_1 \xleftarrow{\$} \mathbb{F}_2^n$ ;
4    $C_1 \leftarrow E_K(P_1)$ ;
5    $P_2 \leftarrow P_1 \oplus \Delta_i$ ;
6    $C_2 \leftarrow E_K(P_2)$ ;
7   if  $C_1 \oplus C_2 = \Delta_o$  then
8      $T \leftarrow T + 1$ ;
9 if  $T \sim \mathcal{N}(\mu = Np, \sigma^2 = Np(1 - p))$  then
10  return 0; // real cipher
11 else
12  return 1; // ideal cipher
```

$$N \approx \mathcal{O}(p^{-1}).$$

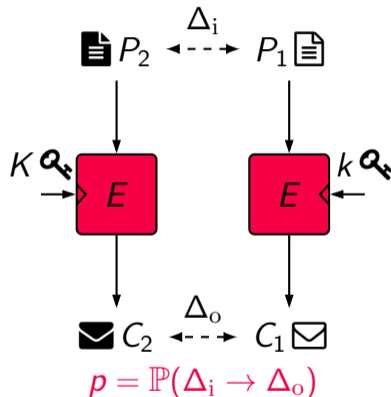

Analytical Estimation of Differential Probability

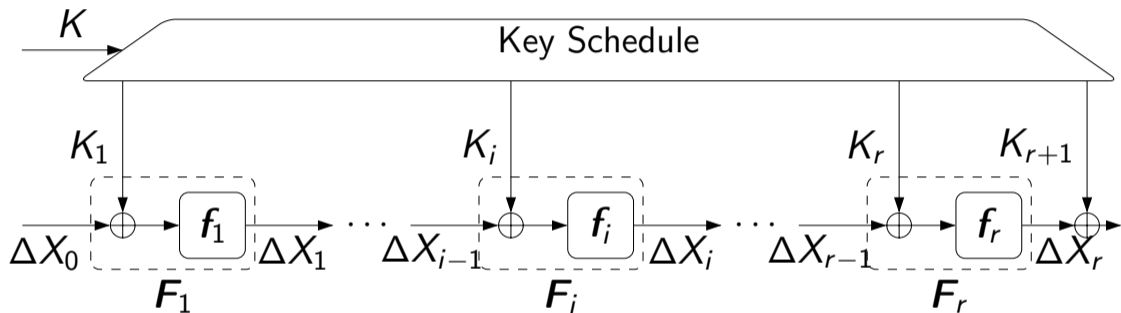

$$\mathbb{P}(\Delta X_r = \Delta_r \mid \Delta X_0 = \Delta_0) = \sum_{\Delta_1, \dots, \Delta_{r-1}} \prod_{i=1}^r \mathbb{P}(f_i(X) \oplus f_i(X \oplus \Delta_{i-1}) = \Delta_i).$$

Difference Distribution Table (DDT) – I

We need a tool to handle the nonlinear operations

Differential Distribution Table (DDT)

For a vectorial Boolean function $S : \mathbb{F}_2^n \rightarrow \mathbb{F}_2^m$, the DDT is a $2^n \times 2^m$ table whose rows correspond to the input difference Δ_i to S and whose columns correspond to the output difference Δ_o of S . The entry at index (Δ_i, Δ_o) is

$$\text{DDT}(\Delta_i, \Delta_o) = |\{x \in \mathbb{F}_2^n : S(x) \oplus S(x \oplus \Delta_i) = \Delta_o\}|.$$

$$\mathbb{P}(\Delta_i, \Delta_o) = 2^{-n} \cdot \text{DDT}(\Delta_i, \Delta_o)$$

Difference Distribution Table (DDT) – II

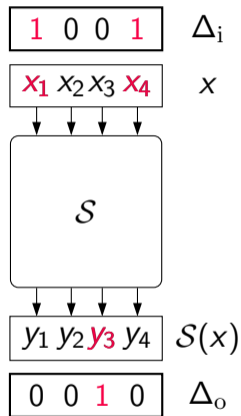

$$\mathbb{P}(9, 2) = \frac{4}{16}$$

| $\Delta_i \setminus \Delta_o$ | 0 | 1 | 2 | 3 | 4 | 5 | 6 | 7 | 8 | 9 | a | b | c | d | e | f |
|-------------------------------|----|---|---|---|---|---|---|---|---|---|---|---|---|---|---|---|
| 0 | 16 | 0 | 0 | 0 | 0 | 0 | 0 | 0 | 0 | 0 | 0 | 0 | 0 | 0 | 0 | 0 |
| 1 | 0 | 0 | 0 | 0 | 2 | 2 | 2 | 2 | 0 | 0 | 0 | 0 | 2 | 2 | 2 | 2 |
| 2 | 0 | 2 | 0 | 2 | 0 | 0 | 0 | 4 | 0 | 2 | 2 | 0 | 0 | 0 | 2 | 2 |
| 3 | 0 | 2 | 0 | 2 | 0 | 0 | 4 | 0 | 0 | 2 | 2 | 0 | 0 | 0 | 2 | 2 |
| 4 | 0 | 0 | 0 | 0 | 0 | 0 | 0 | 0 | 0 | 4 | 4 | 2 | 2 | 2 | 2 | 2 |
| 5 | 0 | 0 | 0 | 0 | 2 | 2 | 2 | 2 | 0 | 0 | 4 | 4 | 0 | 0 | 0 | 0 |
| 6 | 0 | 2 | 0 | 2 | 0 | 4 | 0 | 0 | 0 | 2 | 2 | 0 | 2 | 2 | 0 | 0 |
| 7 | 0 | 2 | 0 | 2 | 4 | 0 | 0 | 0 | 0 | 2 | 2 | 0 | 2 | 2 | 0 | 0 |
| 8 | 0 | 0 | 0 | 0 | 0 | 0 | 0 | 0 | 0 | 0 | 0 | 4 | 4 | 4 | 4 | 4 |
| 9 | 0 | 4 | 4 | 0 | 0 | 0 | 0 | 0 | 4 | 0 | 4 | 0 | 0 | 0 | 0 | 0 |
| a | 0 | 0 | 2 | 2 | 2 | 0 | 0 | 2 | 4 | 0 | 0 | 0 | 0 | 2 | 0 | 2 |
| b | 0 | 0 | 2 | 2 | 0 | 2 | 2 | 0 | 4 | 0 | 0 | 0 | 2 | 0 | 2 | 0 |
| c | 0 | 4 | 4 | 0 | 2 | 2 | 2 | 2 | 0 | 0 | 0 | 0 | 0 | 0 | 0 | 0 |
| d | 0 | 0 | 0 | 0 | 2 | 2 | 2 | 2 | 0 | 4 | 0 | 4 | 0 | 0 | 0 | 0 |
| e | 0 | 0 | 2 | 2 | 0 | 2 | 2 | 0 | 4 | 0 | 0 | 0 | 0 | 2 | 0 | 2 |
| f | 0 | 0 | 2 | 2 | 2 | 0 | 0 | 2 | 4 | 0 | 0 | 0 | 2 | 0 | 2 | 0 |

Linear Attacks [Mat93]

Input: E_K , Given N distinct plaintext-ciphertext pairs (P_i, C_i) , $\mathbf{c} = \mathbb{C}(\lambda_i, \lambda_o)$

Output: 0: **real** cipher, 1: **ideal** cipher

```
1 Initialize a counter list  $V[z] \leftarrow 0$  for  $z \in \{0, 1\}$ ;  
2 for  $t = 0, \dots, N - 1$  do  
3    $b_1 \leftarrow \lambda_i \cdot P_t$ ;  
4    $b_2 \leftarrow \lambda_o \cdot C_t$ ;  
5    $V[b_1 \oplus b_2] \leftarrow V[b_1 \oplus b_2] + 1$ ;  
6 if  $V[0] \sim \mathcal{N}(\mu_0 = N \frac{1+c}{2}, \sigma_0^2 = \frac{N(1-c^2)}{4})$ . then  
7   return 0; // real cipher  
8 else  
9   return 1; // ideal cipher
```

$$N = \mathcal{O}(c^{-2}).$$

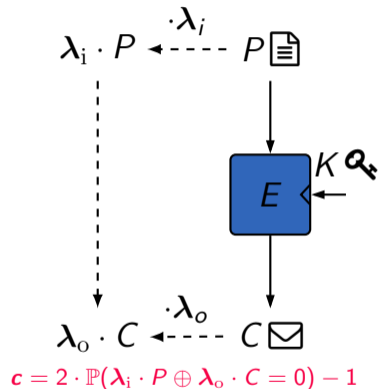

Analytical Estimation of Correlation

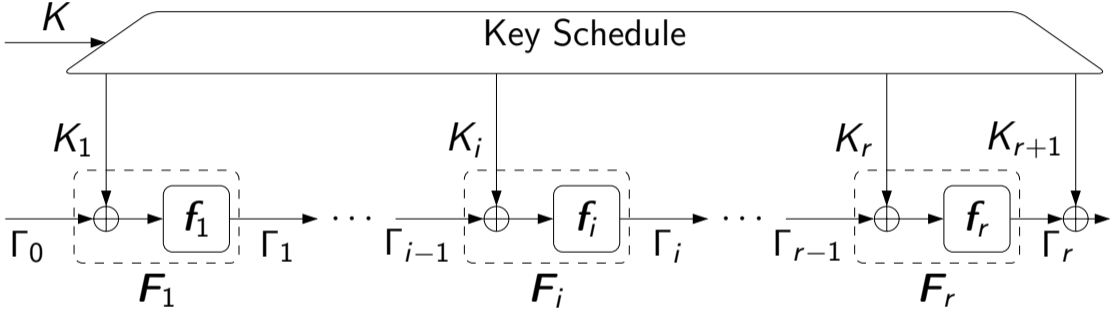

$$\mathbb{C}(\Gamma_0, \Gamma_{r+1}) \approx (-1)^{(\Gamma_0 \cdot K_1 \oplus \dots \oplus \Gamma_r \cdot K_{r+1})} \prod_{i=1}^r \mathbb{C}_{f_i}(\Gamma_{i-1}, \Gamma_i).$$

Linear Approximation Table (LAT) – I

We need a metric to measure the quality of a linear approximation.

Linear Approximation Table (LAT)

For a vectorial Boolean function $S : \mathbb{F}_2^n \rightarrow \mathbb{F}_2^m$, the LAT of S is a $2^n \times 2^m$ table whose rows correspond to the input mask λ_i to S and whose columns correspond to the output mask λ_o of S . The entry at index (λ_i, λ_o) is

$$\text{LAT}(\lambda_i, \lambda_o) = |\text{LAT}_0(\lambda_i, \lambda_o)| - |\text{LAT}_1(\lambda_i, \lambda_o)|,$$

where $\text{LAT}_b(\lambda_i, \lambda_o) = \{x \in \mathbb{F}_2^n : \lambda_i \cdot x \oplus \lambda_o \cdot S(x) = b\}$.

$$\mathbb{C}(\lambda_i, \lambda_o) = 2^{-n} \cdot \text{LAT}(\lambda_i, \lambda_o)$$

Linear Approximation Table (LAT) – II

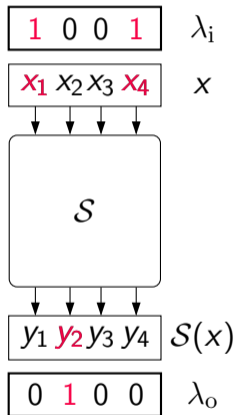

$$\mathbb{C}(9, 4) = \frac{8}{16}$$

| $\lambda_i \setminus \lambda_o$ | 0 | 1 | 2 | 3 | 4 | 5 | 6 | 7 | 8 | 9 | a | b | c | d | e | f |
|---------------------------------|----|----|----|----|----|----|----|----|----|----|----|----|----|----|----|----|
| 0 | 16 | 0 | 0 | 0 | 0 | 0 | 0 | 0 | 0 | 0 | 0 | 0 | 0 | 0 | 0 | 0 |
| 1 | 0 | 0 | 4 | -4 | 0 | -8 | -4 | -4 | 0 | 0 | 4 | -4 | -8 | 0 | 4 | 4 |
| 2 | 0 | 0 | 0 | 0 | 0 | 0 | 0 | 0 | 0 | 8 | 8 | 0 | 0 | 8 | -8 | 0 |
| 3 | 0 | -8 | 4 | 4 | 0 | 0 | -4 | 4 | 0 | 0 | -4 | 4 | -8 | 0 | -4 | -4 |
| 4 | 0 | 4 | 0 | 4 | 0 | 4 | 8 | -4 | 0 | 4 | 0 | 4 | -8 | -4 | 0 | 4 |
| 5 | 0 | 4 | -4 | -8 | 0 | -4 | -4 | 0 | 0 | 4 | -4 | 8 | 0 | -4 | -4 | 0 |
| 6 | 0 | -4 | 8 | 4 | 0 | -4 | 0 | -4 | 0 | 4 | 0 | 4 | 8 | -4 | 0 | 4 |
| 7 | 0 | 4 | 4 | 0 | 0 | -4 | 4 | -8 | 0 | -4 | -4 | 0 | 0 | 4 | -4 | -8 |
| 8 | 0 | 0 | 0 | 0 | 0 | 0 | 0 | 0 | 0 | 8 | 8 | 0 | 0 | 8 | -8 | -8 |
| 9 | 0 | 0 | -4 | 4 | 8 | 0 | -4 | -4 | 0 | 0 | 4 | -4 | 0 | -8 | -4 | -4 |
| a | 0 | 8 | 0 | 8 | 0 | -8 | 0 | 8 | 0 | 0 | 0 | 0 | 0 | 0 | 0 | 0 |
| b | 0 | 0 | -4 | 4 | -8 | 0 | -4 | -4 | 0 | 8 | -4 | -4 | 0 | 0 | 4 | -4 |
| c | 0 | 4 | 0 | 4 | 0 | 4 | -8 | -4 | 8 | -4 | 0 | 4 | 0 | 4 | 0 | 4 |
| d | 0 | 4 | 4 | 0 | -8 | 4 | -4 | 0 | -8 | -4 | 4 | 0 | 0 | -4 | -4 | 0 |
| e | 0 | 4 | 8 | -4 | 0 | 4 | 0 | 4 | 8 | 4 | 0 | -4 | 0 | -4 | 0 | -4 |
| f | 0 | -4 | -4 | 0 | -8 | -4 | 4 | 0 | 8 | -4 | 4 | 0 | 0 | -4 | -4 | 0 |

Boomerang Distinguishers [Wag99]

Input: $E_K, (\Delta, \nabla), N, P = \mathbb{P}(P_3 \oplus P_4 = \Delta)$

Output: 0: real cipher, 1: ideal cipher

```
1 Initialize counter  $T$  with zero;
2 for  $i = 0, \dots, N - 1$  do
3    $P_1 \xleftarrow{\$} \mathbb{F}_2^n$ ;  $P_2 = P_1 \oplus \Delta$ ;
4    $C_1 \leftarrow E_K(P_1)$ ,  $C_2 \leftarrow E_K(P_2)$ ;
5    $C_3 \leftarrow C_1 \oplus \nabla$ ,  $C_4 \leftarrow C_2 \oplus \nabla$ ;
6    $P_3 \leftarrow D_K(C_3)$ ,  $P_4 \leftarrow D_K(C_4)$ ;
7   if  $P_3 \oplus P_4 = \Delta$  then
8      $T \leftarrow T + 1$ ;
9 if  $T \sim \mathcal{N}(\mu = NP, \sigma^2 = NP(1 - P))$  then
10  return 0; // real cipher
11 else
12  return 1; // ideal cipher
```

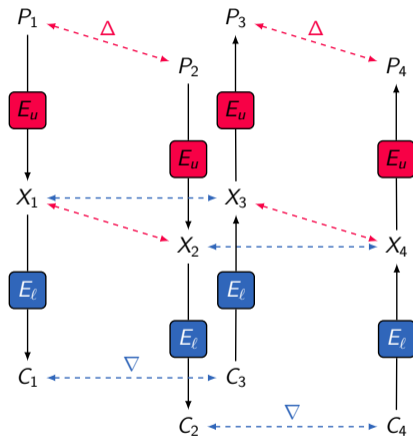

Probability of Boomerang Distinguishers [Wag99]

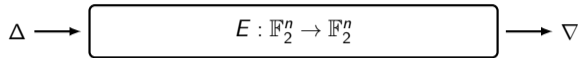

$$0 \leq \mathbb{P}(\Delta \xrightarrow{E} \nabla) \lll 2^{-n}$$

Probability of Boomerang Distinguishers [Wag99]

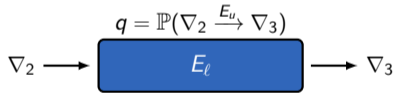
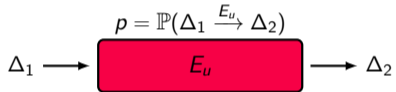

Probability of Boomerang Distinguishers [Wag99]

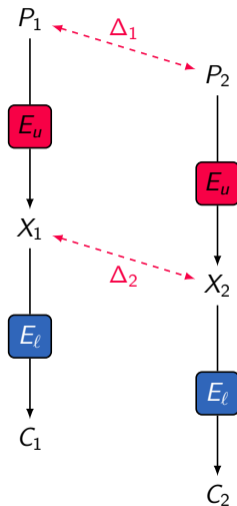
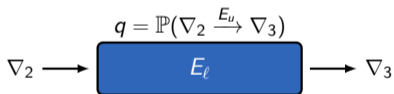
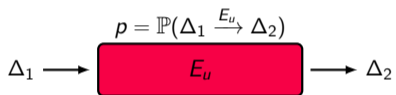

Probability of Boomerang Distinguishers [Wag99]

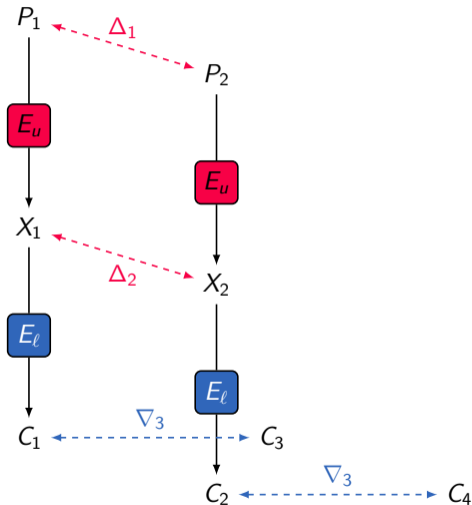
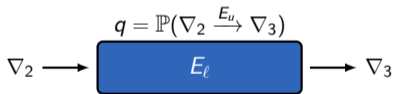
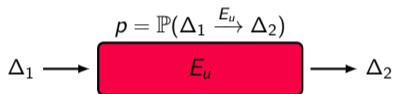

Probability of Boomerang Distinguishers [Wag99]

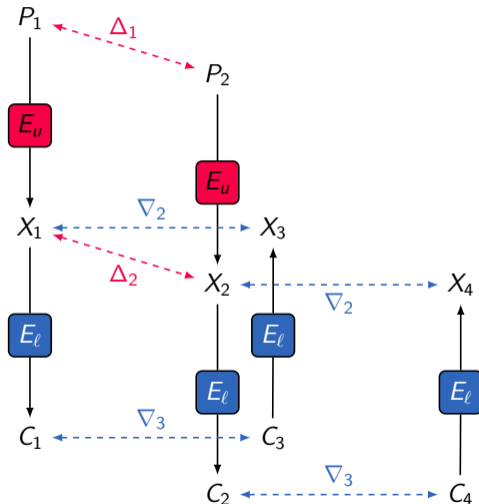
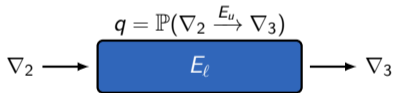
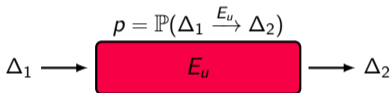

Probability of Boomerang Distinguishers [Wag99]

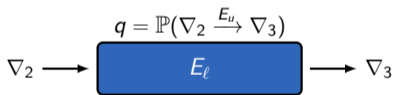
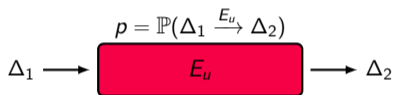

$$\mathbb{P}(P_3 \oplus P_4 = \Delta_1) = p^2 q^2$$

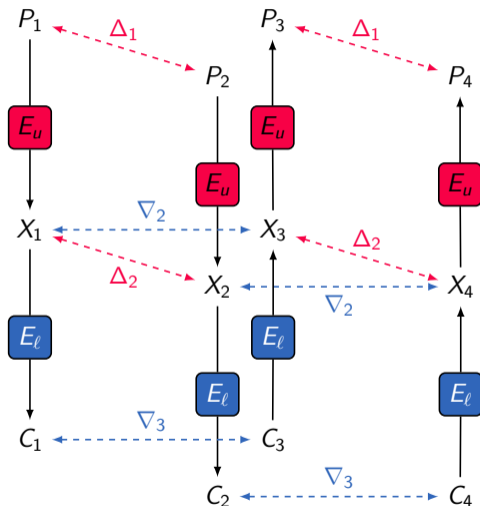

Sandwiching the Differentials! [DKS10; DKS14]

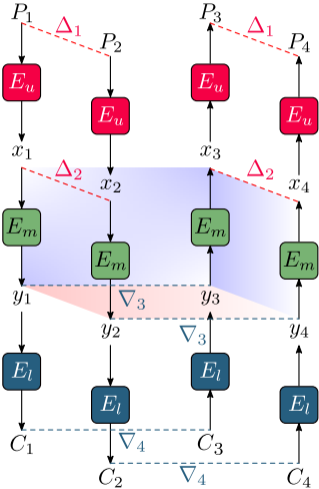

Sandwiching the Differentials! [DKS10; DKS14]

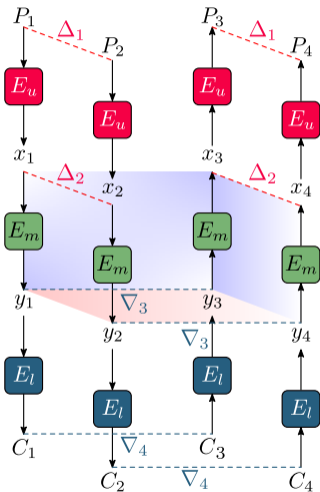

$$\mathbb{P}(P_3 \oplus P_4 = \Delta_1) \approx p^2 \times r \times q^2$$

$$r = \mathbb{P}(\Delta_2 \Leftrightarrow \nabla_3)$$

Boomerang Connectivity Table (BCT) [Cid+18]

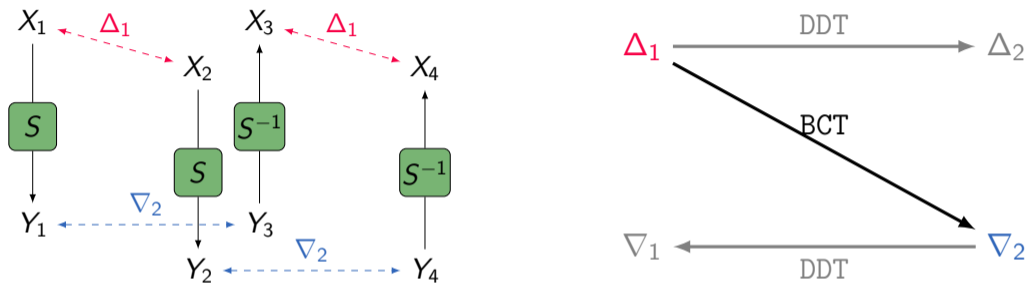

$$\text{BCT}(\Delta_1, \nabla_2) := \#\{X \in \mathbb{F}_2^n \mid S^{-1}(S(X) \oplus \nabla_2) \oplus S^{-1}(S(X \oplus \Delta_1) \oplus \nabla_2) = \Delta_1\}$$

$$\mathbb{P}(\Delta_1 \rightleftharpoons \nabla_2) = 2^{-n} \cdot \text{BCT}(\Delta_1, \nabla_2)$$

Generalized BCT Framework - I

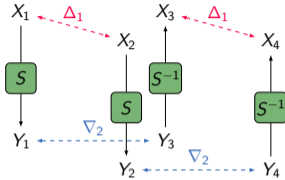

$$\Delta_1 \longrightarrow \Delta_2$$

$$\nabla_1 \longleftarrow \nabla_2$$

- ✔ $\mathcal{X}_{\text{DDT}}(\Delta_1, \Delta_2) = \{x : S(x) \oplus S(x \oplus \Delta_1) = \Delta_2\}$, $\text{DDT}(\Delta_1, \Delta_2) = \#\mathcal{X}_{\text{DDT}}(\Delta_1, \Delta_2)$
- ✔ $\mathcal{X}_{\text{BCT}}(\Delta_1, \nabla_2) = \{x : S^{-1}(S(x) \oplus \nabla_2) \oplus S^{-1}(S(x \oplus \Delta_1) \oplus \nabla_2) = \Delta_1\}$, $\text{BCT}(\Delta_1, \nabla_2) = \#\mathcal{X}_{\text{BCT}}(\Delta_1, \nabla_2)$
- ✔ $\text{UBCT}(\Delta_1, \Delta_2, \nabla_2) = \#\{x : x \in \mathcal{X}_{\text{BCT}}(\Delta_1, \nabla_2) \cap \mathcal{X}_{\text{DDT}}(\Delta_1, \Delta_2)\}$ [WP19]
- ✔ $\text{LBCT}(\Delta_1, \nabla_1, \nabla_2) = \#\{x : x \in \mathcal{X}_{\text{BCT}}(\Delta_1, \nabla_2) \cap \mathcal{X}_{\text{DDT}}(\nabla_1, \nabla_2)\}$ [DDV20; SQH19]
- ✔ $\text{EBCT}(\Delta_1, \Delta_2, \nabla_1, \nabla_2) = \#\{x : x \in \mathcal{X}_{\text{BCT}}(\Delta_1, \nabla_2) \cap \mathcal{X}'_{\text{DDT}}(\Delta_1, \Delta_2) \cap \mathcal{X}_{\text{DDT}}(\nabla_1, \nabla_2)\}$ [Bou+20; DDV20]

Generalized BCT Framework - I

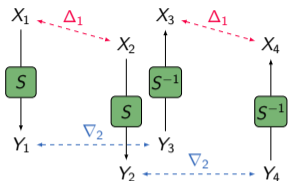

- ✓ $\mathcal{X}_{\text{DDT}}(\Delta_1, \Delta_2) = \{x : S(x) \oplus S(x \oplus \Delta_1) = \Delta_2\}$, $\text{DDT}(\Delta_1, \Delta_2) = \#\mathcal{X}_{\text{DDT}}(\Delta_1, \Delta_2)$
- ✓ $\mathcal{X}_{\text{BCT}}(\Delta_1, \nabla_2) = \{x : S^{-1}(S(x) \oplus \nabla_2) \oplus S^{-1}(S(x \oplus \Delta_1) \oplus \nabla_2) = \Delta_1\}$, $\text{BCT}(\Delta_1, \nabla_2) = \#\mathcal{X}_{\text{BCT}}(\Delta_1, \nabla_2)$
- ✓ $\text{UBCT}(\Delta_1, \Delta_2, \nabla_2) = \#\{x : x \in \mathcal{X}_{\text{BCT}}(\Delta_1, \nabla_2) \cap \mathcal{X}_{\text{DDT}}(\Delta_1, \Delta_2)\}$ [WP19]
- ✓ $\text{LBCT}(\Delta_1, \nabla_1, \nabla_2) = \#\{x : x \in \mathcal{X}_{\text{BCT}}(\Delta_1, \nabla_2) \cap \mathcal{X}_{\text{DDT}}(\nabla_1, \nabla_2)\}$ [DDV20; SQH19]
- ✓ $\text{EBCT}(\Delta_1, \Delta_2, \nabla_1, \nabla_2) = \#\{x : x \in \mathcal{X}_{\text{BCT}}(\Delta_1, \nabla_2) \cap \mathcal{X}'_{\text{DDT}}(\Delta_1, \Delta_2) \cap \mathcal{X}_{\text{DDT}}(\nabla_1, \nabla_2)\}$ [Bou+20; DDV20]

Generalized BCT Framework - I

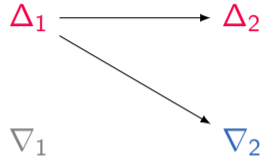
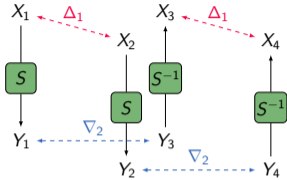

- ✔ $\mathcal{X}_{\text{DDT}}(\Delta_1, \Delta_2) = \{x : S(x) \oplus S(x \oplus \Delta_1) = \Delta_2\}$, $\text{DDT}(\Delta_1, \Delta_2) = \#\mathcal{X}_{\text{DDT}}(\Delta_1, \Delta_2)$
- ✔ $\mathcal{X}_{\text{BCT}}(\Delta_1, \nabla_2) = \{x : S^{-1}(S(x) \oplus \nabla_2) \oplus S^{-1}(S(x \oplus \Delta_1) \oplus \nabla_2) = \Delta_1\}$, $\text{BCT}(\Delta_1, \nabla_2) = \#\mathcal{X}_{\text{BCT}}(\Delta_1, \nabla_2)$
- ✔ $\text{UBCT}(\Delta_1, \Delta_2, \nabla_2) = \#\{x : x \in \mathcal{X}_{\text{BCT}}(\Delta_1, \nabla_2) \cap \mathcal{X}_{\text{DDT}}(\Delta_1, \Delta_2)\}$ [WP19]
- ✔ $\text{LBCT}(\Delta_1, \nabla_1, \nabla_2) = \#\{x : x \in \mathcal{X}_{\text{BCT}}(\Delta_1, \nabla_2) \cap \mathcal{X}_{\text{DDT}}(\nabla_1, \nabla_2)\}$ [DDV20; SQH19]
- ✔ $\text{EBCT}(\Delta_1, \Delta_2, \nabla_1, \nabla_2) = \#\{x : x \in \mathcal{X}_{\text{BCT}}(\Delta_1, \nabla_2) \cap \mathcal{X}'_{\text{DDT}}(\Delta_1, \Delta_2) \cap \mathcal{X}_{\text{DDT}}(\nabla_1, \nabla_2)\}$ [Bou+20; DDV20]

Generalized BCT Framework - I

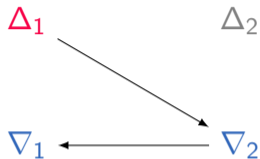
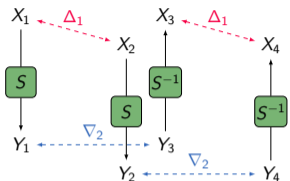

- ✔ $\mathcal{X}_{\text{DDT}}(\Delta_1, \Delta_2) = \{x : S(x) \oplus S(x \oplus \Delta_1) = \Delta_2\}$, $\text{DDT}(\Delta_1, \Delta_2) = \#\mathcal{X}_{\text{DDT}}(\Delta_1, \Delta_2)$
- ✔ $\mathcal{X}_{\text{BCT}}(\Delta_1, \nabla_2) = \{x : S^{-1}(S(x) \oplus \nabla_2) \oplus S^{-1}(S(x \oplus \Delta_1) \oplus \nabla_2) = \Delta_1\}$, $\text{BCT}(\Delta_1, \nabla_2) = \#\mathcal{X}_{\text{BCT}}(\Delta_1, \nabla_2)$
- ✔ $\text{UBCT}(\Delta_1, \Delta_2, \nabla_2) = \#\{x : x \in \mathcal{X}_{\text{BCT}}(\Delta_1, \nabla_2) \cap \mathcal{X}_{\text{DDT}}(\Delta_1, \Delta_2)\}$ [WP19]
- ✔ $\text{LBCT}(\Delta_1, \nabla_1, \nabla_2) = \#\{x : x \in \mathcal{X}_{\text{BCT}}(\Delta_1, \nabla_2) \cap \mathcal{X}_{\text{DDT}}(\nabla_1, \nabla_2)\}$ [DDV20; SQH19]
- ✔ $\text{EBCT}(\Delta_1, \Delta_2, \nabla_1, \nabla_2) = \#\{x : x \in \mathcal{X}_{\text{BCT}}(\Delta_1, \nabla_2) \cap \mathcal{X}'_{\text{DDT}}(\Delta_1, \Delta_2) \cap \mathcal{X}_{\text{DDT}}(\nabla_1, \nabla_2)\}$ [Bou+20; DDV20]

Generalized BCT Framework - I

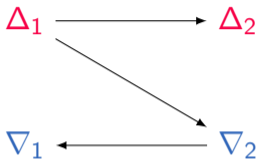
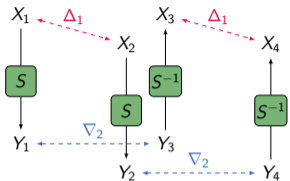

- ✔ $\mathcal{X}_{\text{DDT}}(\Delta_1, \Delta_2) = \{x : S(x) \oplus S(x \oplus \Delta_1) = \Delta_2\}$, $\text{DDT}(\Delta_1, \Delta_2) = \#\mathcal{X}_{\text{DDT}}(\Delta_1, \Delta_2)$
- ✔ $\mathcal{X}_{\text{BCT}}(\Delta_1, \nabla_2) = \{x : S^{-1}(S(x) \oplus \nabla_2) \oplus S^{-1}(S(x \oplus \Delta_1) \oplus \nabla_2) = \Delta_1\}$, $\text{BCT}(\Delta_1, \nabla_2) = \#\mathcal{X}_{\text{BCT}}(\Delta_1, \nabla_2)$
- ✔ $\text{UBCT}(\Delta_1, \Delta_2, \nabla_2) = \#\{x : x \in \mathcal{X}_{\text{BCT}}(\Delta_1, \nabla_2) \cap \mathcal{X}_{\text{DDT}}(\Delta_1, \Delta_2)\}$ [WP19]
- ✔ $\text{LBCT}(\Delta_1, \nabla_1, \nabla_2) = \#\{x : x \in \mathcal{X}_{\text{BCT}}(\Delta_1, \nabla_2) \cap \mathcal{X}_{\text{DDT}}(\nabla_1, \nabla_2)\}$ [DDV20; SQH19]
- ✔ $\text{EBCT}(\Delta_1, \Delta_2, \nabla_1, \nabla_2) = \#\{x : x \in \mathcal{X}_{\text{BCT}}(\Delta_1, \nabla_2) \cap \mathcal{X}_{\text{DDT}}(\Delta_1, \Delta_2) \cap \mathcal{X}_{\text{DDT}}(\nabla_1, \nabla_2)\}$ [Bou+20; DDV20]

Generalized BCT Framework (GBCT) - II

- Double Boomerang Connectivity Table (DBCT) [HB21]

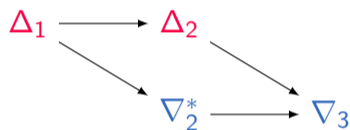

$$\text{DBCT}^+(\Delta_1, \Delta_2, \nabla_3) = \sum_{\nabla_2} \text{UBCT}(\Delta_1, \Delta_2, \nabla_2) \cdot \text{LBCT}(\Delta_2, \nabla_2, \nabla_3)$$

$$\text{DBCT}^-(\Delta_1, \nabla_2, \nabla_3) = \sum_{\Delta_2} \text{UBCT}(\Delta_1, \Delta_2, \nabla_2) \cdot \text{LBCT}(\Delta_2, \nabla_2, \nabla_3).$$

$$\text{DBCT}(\Delta_1, \nabla_3) = \sum_{\Delta_2} \text{DBCT}^+(\Delta_1, \Delta_2, \nabla_3) = \sum_{\nabla_2} \text{DBCT}^-(\Delta_1, \nabla_2, \nabla_3).$$

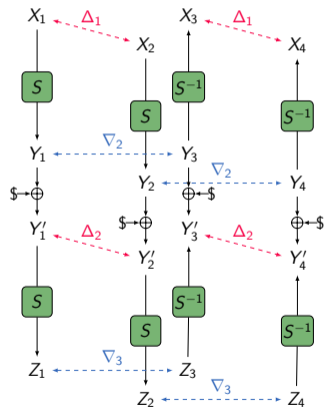

Generalized BCT Framework (GBCT) - II

- Double Boomerang Connectivity Table (DBCT) [HB21]

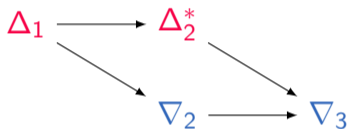

✔ $\text{DBCT}^+(\Delta_1, \Delta_2, \nabla_3) = \sum_{\nabla_2} \text{UBCT}(\Delta_1, \Delta_2, \nabla_2) \cdot \text{LBCT}(\Delta_2, \nabla_2, \nabla_3)$

✔ $\text{DBCT}^-(\Delta_1, \nabla_2, \nabla_3) = \sum_{\Delta_2} \text{UBCT}(\Delta_1, \Delta_2, \nabla_2) \cdot \text{LBCT}(\Delta_2, \nabla_2, \nabla_3)$.

✔ $\text{DBCT}(\Delta_1, \nabla_3) = \sum_{\Delta_2} \text{DBCT}^+(\Delta_1, \Delta_2, \nabla_3) = \sum_{\nabla_2} \text{DBCT}^-(\Delta_1, \nabla_2, \nabla_3)$.

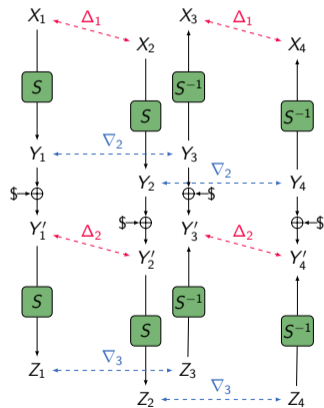

Generalized BCT Framework (GBCT) - II

- Double Boomerang Connectivity Table (DBCT) [HB21]

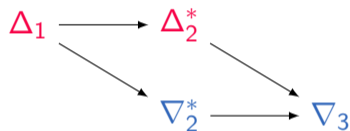

$$\text{DBCT}^{\perp}(\Delta_1, \Delta_2, \nabla_3) = \sum_{\nabla_2} \text{UBCT}(\Delta_1, \Delta_2, \nabla_2) \cdot \text{LBCT}(\Delta_2, \nabla_2, \nabla_3)$$

$$\text{DBCT}^{-1}(\Delta_1, \nabla_2, \nabla_3) = \sum_{\Delta_2} \text{UBCT}(\Delta_1, \Delta_2, \nabla_2) \cdot \text{LBCT}(\Delta_2, \nabla_2, \nabla_3).$$

$$\text{DBCT}(\Delta_1, \nabla_3) = \sum_{\Delta_2} \text{DBCT}^{\perp}(\Delta_1, \Delta_2, \nabla_3) = \sum_{\nabla_2} \text{DBCT}^{-1}(\Delta_1, \nabla_2, \nabla_3).$$

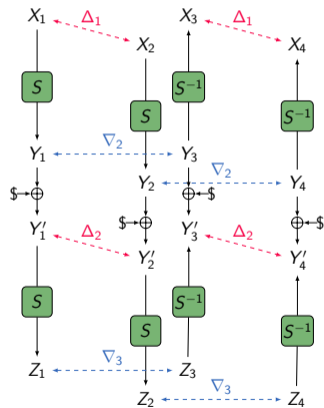

Application of GBCT [HB21]

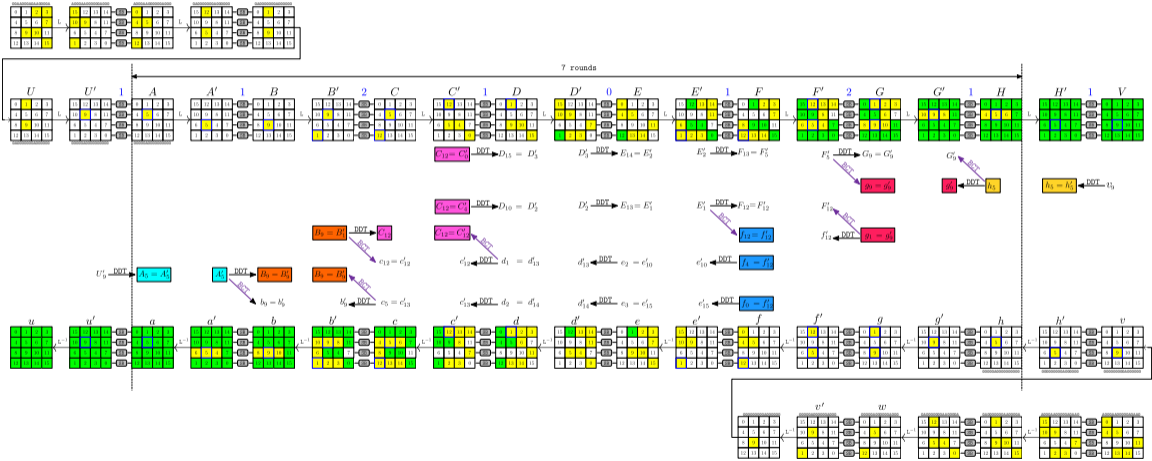

Application of GBCT [HB21]

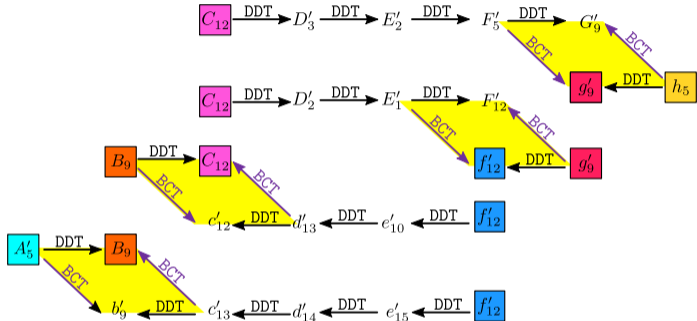

$$\begin{aligned}
 \text{DBCT}_{\text{total}} &= \text{DBCT}^{\perp}(A_5, B_9, c_5) \cdot \text{DBCT}^{\perp}(B_9, C_{12}, d_1) \cdot \text{DBCT}^{\perp}(E'_1, f'_{12}, g'_9) \cdot \text{DBCT}^{\perp}(F'_5, g'_9, h_5) \\
 \text{Pr}_{\text{total}} &= \Pr(d_1 \xleftarrow{2 \text{ DDT}} f'_{12}) \cdot \Pr(c_5 \xleftarrow{3 \text{ DDT}} f'_{12}) \cdot \Pr(C_{12} \xrightarrow{2 \text{ DDT}} E'_1) \cdot \Pr(C_{12} \xrightarrow{3 \text{ DDT}} F'_5) \\
 r &= 2^{-8 \cdot n} \cdot \sum_{B_9} \sum_{C_{12}} \sum_{g'_9} \sum_{f'_{12}} \sum_{c_5} \sum_{d_1} \sum_{E'_1} \sum_{F'_5} \text{DBCT}_{\text{total}} \cdot \text{Pr}_{\text{total}}.
 \end{aligned}$$

Differential-Linear (DL) Attack I [LH94]

Input: $E_K, (\Delta, \lambda), N, c = \mathbb{C}(\Delta, \lambda)$

Output: 0: **real** cipher, 1: **ideal** cipher

```
1 Initialize a counter list  $V[z] \leftarrow 0$  for  $z \in \{0, 1\}$ ;  
2 for  $i = 0, \dots, N - 1$  do  
3    $P_1 \xleftarrow{\$} \mathbb{F}_2^n$ ;  
4    $b_1 \leftarrow \lambda \cdot E_K(P_1)$ ;  
5    $P_2 \leftarrow P_1 \oplus \Delta$ ;  
6    $b_2 \leftarrow \lambda \cdot E_K(P_2)$ ;  
7    $V[b_1 \oplus b_2] \leftarrow V[b_1 \oplus b_2] + 1$ ;  
8 if  $V[0] \sim \mathcal{N}(\mu = N \frac{1+c}{2}, \sigma^2 = N \frac{1-c^2}{4})$  then  
9   return 0; // real cipher  
10 else  
11   return 1; // ideal cipher
```

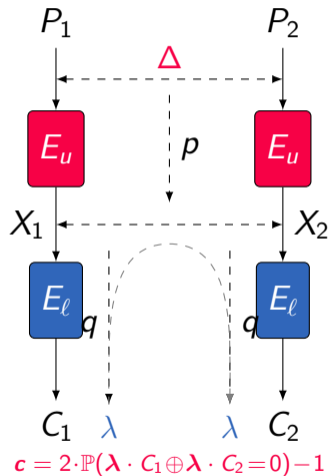

Differential-Linear (DL) Attack II [LH94]

- $p = \mathbb{P}(\Delta_i \xrightarrow{E_u} \Delta_m)$
- $q = \mathbb{C}(\lambda_m \xrightarrow{E_\ell} \lambda_o) = 2 \cdot \mathbb{P}(\lambda_m \cdot X \oplus \lambda_o \cdot E_\ell(X) = 0) - 1$
- Assumptions ($\Delta X = X_1 \oplus X_2$):
 1. E_u , and E_ℓ are statistically independent
 2. $\mathbb{P}(\lambda_m \cdot \Delta X = 0) = 1/2$ when $\Delta X \neq \Delta_m$
- $\mathcal{C} = \mathbb{C}(\lambda_o \cdot \Delta C) \approx (-1)^{\lambda_m \cdot \Delta_m} \cdot pq^2 = \pm pq^2$
- Time/Data complexity: $\mathcal{O}(\mathcal{C}^{-2})$

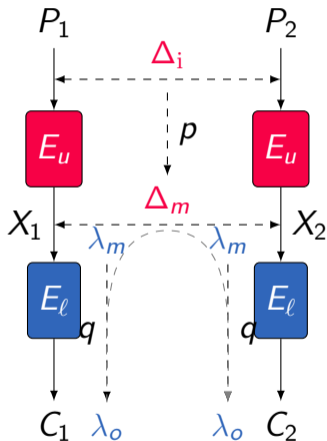

Sandwich Framework for DL Attack [BLN14; DKS14; Bar+19]

- $\mathbb{R}(\Delta X, \Lambda Y) = \mathbb{C}(\Lambda Y \cdot E_m(X) \oplus \Lambda Y \cdot E_m(X \oplus \Delta X))$
- $\mathbb{C}(\lambda_o \cdot \Delta C) = \sum_{\Delta X, \Lambda Y} \mathbb{P}(\Delta_i, \Delta X) \cdot \mathbb{R}(\Delta X, \Lambda Y) \cdot \mathbb{C}^2(\Lambda Y, \lambda_o)$
- $\mathbb{P}(\Delta_i \xrightarrow{E_u} \Delta_m) = p$
- $\mathbb{R}(\Delta_m, \lambda_m) = r$
- $\mathbb{C}(\lambda_m \xrightarrow{E_\ell} \lambda_o) = q$
- $\mathbb{C}(\lambda_o \cdot \Delta C) \approx prq^2$

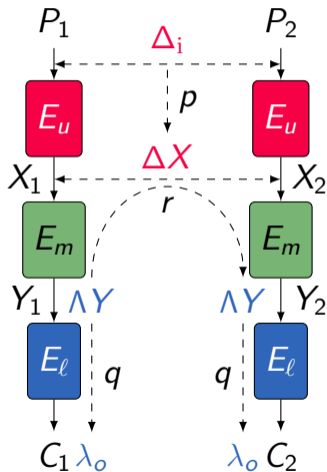

Sandwich Framework for DL Attack [BLN14; DKS14; Bar+19]

- $\mathbb{R}(\Delta X, \Lambda Y) = \mathbb{C}(\Lambda Y \cdot E_m(X) \oplus \Lambda Y \cdot E_m(X \oplus \Delta X))$
- $\mathbb{C}(\lambda_o \cdot \Delta C) = \sum_{\Delta X, \Lambda Y} \mathbb{P}(\Delta_i, \Delta X) \cdot \mathbb{R}(\Delta X, \Lambda Y) \cdot \mathbb{C}^2(\Lambda Y, \lambda_o)$
- $\mathbb{P}(\Delta_i \xrightarrow{E_u} \Delta_m) = p$
- $\mathbb{R}(\Delta_m, \lambda_m) = r$
- $\mathbb{C}(\lambda_m \xrightarrow{E_\ell} \lambda_o) = q$
- $\mathbb{C}(\lambda_o \cdot \Delta C) \approx prq^2$

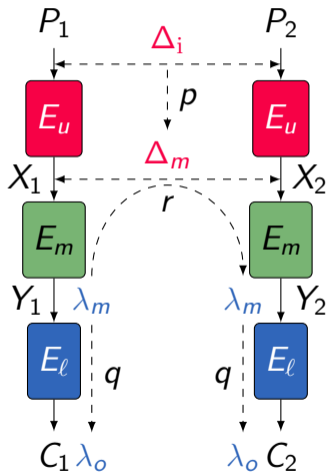

Differential-Linear Connectivity Table (DLCT) [Bar+19]



$$\text{DLCT}_b(\Delta_i, \lambda_o) = \{x \in \mathbb{F}_2^n : \lambda_o \cdot S(x) \oplus \lambda_o \cdot S(x \oplus \Delta_i) = b\}$$

$$\text{DLCT}(\Delta_i, \lambda_o) = |\text{DLCT}_0(\Delta_i, \lambda_o)| - |\text{DLCT}_1(\Delta_i, \lambda_o)|$$

$$\mathbb{C}_{\text{DLCT}}(\Delta_i, \lambda_o) = 2^{-n} \cdot \text{DLCT}(\Delta_i, \lambda_o)$$

Security of AES Against Differential/Linear Attacks

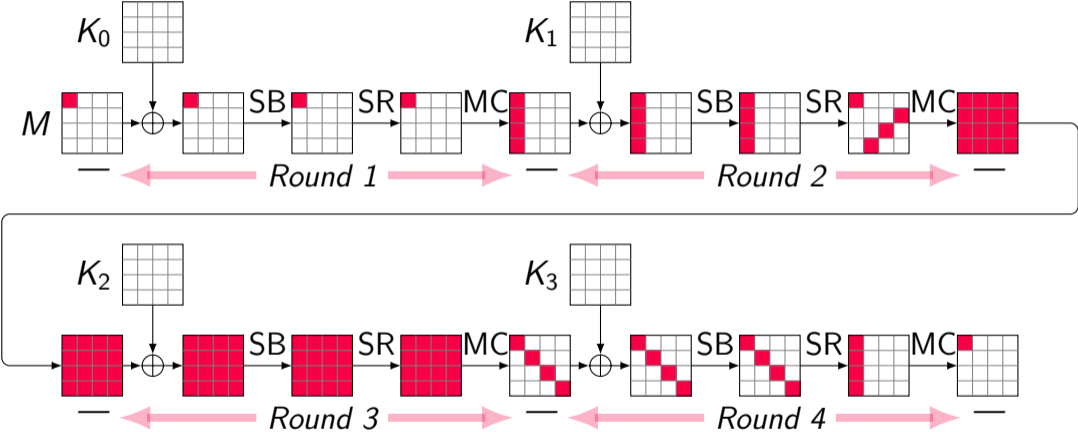

$$\mathbb{P}_{4 \text{ rounds}} \leq 2^{-150}, \quad \mathbb{C}_{4 \text{ rounds}}^2 \leq 2^{-150}$$

A 4-round DL Distinguisher for AES

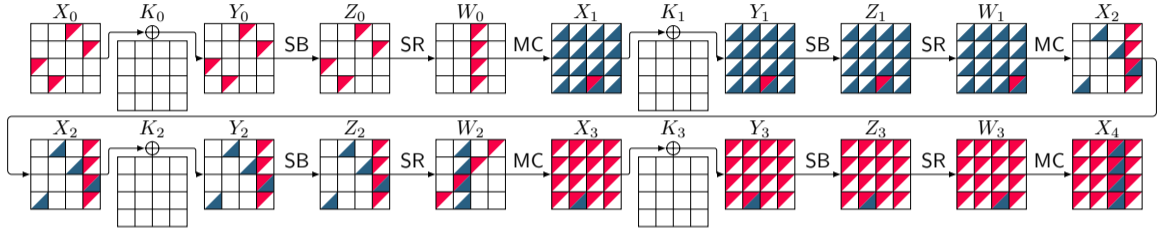

$$r_u = 1, r_m = 3, r_\ell = 0, p = 2^{-24.00}, r = 2^{-7.66}, q^2 = 1, \mathbb{C} = prq^2 = 2^{-31.66}$$

ΔX_0 00005200000000f58f000000007b0000 ΔX_1 000000000000000000000000000000b400
 ΓX_4 0032000000ab00000066000000980000 -

$$2^{63.32} \text{ v.s. } 2^{150}$$

Generalized DLCT Framework



Upper Differential-Linear Connectivity Table (UDLCT)



$$\text{UDLCT}_b(\Delta_i, \Delta_o, \lambda_o) = \{x \in \mathbb{F}_2^n : S(x) \oplus S(x \oplus \Delta_i) = \Delta_o \text{ and } \lambda_o \cdot \Delta_o = b\}$$

$$\text{UDLCT}(\Delta_i, \Delta_o, \lambda_o) = |\text{UDLCT}_0(\Delta_i, \Delta_o, \lambda_o)| - |\text{UDLCT}_1(\Delta_i, \Delta_o, \lambda_o)|$$

$$\mathbb{C}_{\text{UDLCT}}(\Delta_i, \Delta_o, \lambda_o) = 2^{-n} \cdot \text{UDLCT}(\Delta_i, \Delta_o, \lambda_o)$$

Lower Differential-Linear Connectivity Table (LDLCT)

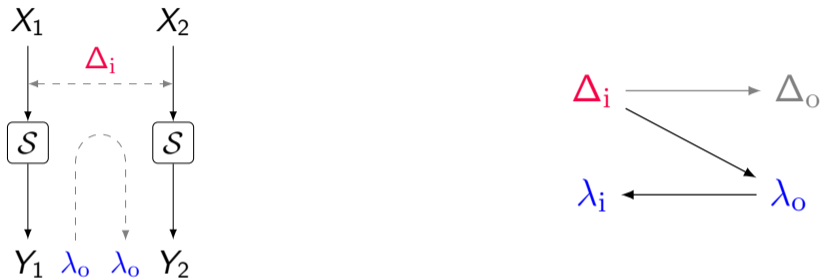

$$\text{LDLCT}_b(\Delta_i, \lambda_i, \lambda_o) = \{x \in \mathbb{F}_2^n : \lambda_i \cdot \Delta_i \oplus \lambda_o \cdot S(x) \oplus \lambda_o \cdot S(x \oplus \Delta_i) = b\}$$

$$\text{LDLCT}(\Delta_i, \lambda_i, \lambda_o) = |\text{LDLCT}_0(\Delta_i, \lambda_i, \lambda_o)| - |\text{LDLCT}_1(\Delta_i, \lambda_i, \lambda_o)|$$

$$\mathbb{C}_{\text{LDLCT}}(\Delta_i, \lambda_i, \lambda_o) = 2^{-n} \cdot \text{LDLCT}(\Delta_i, \lambda_i, \lambda_o)$$

Extended Differential-Linear Connectivity Table (EDLCT)



$$\text{EDLCT}_b(\Delta_i, \Delta_o, \lambda_i, \lambda_o) = \{x \in \mathbb{F}_2^n : S(x) \oplus S(x \oplus \Delta_i) = \Delta_o \text{ and } \lambda_i \cdot \Delta_i \oplus \lambda_o \cdot \Delta_o = b\}$$

$$\text{EDLCT}(\Delta_i, \Delta_o, \lambda_i, \lambda_o) = |\text{EDLCT}_0(\Delta_i, \Delta_o, \lambda_i, \lambda_o)| - |\text{EDLCT}_1(\Delta_i, \Delta_o, \lambda_i, \lambda_o)|$$

$$\mathbb{C}_{\text{EDLCT}}(\Delta_i, \Delta_o, \lambda_i, \lambda_o) = 2^{-n} \cdot \text{EDLCT}(\Delta_i, \Delta_o, \lambda_i, \lambda_o)$$

Double Differential-Linear Connectivity Table (DDLCT)

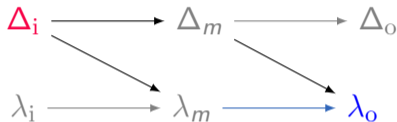

$$\text{DDLCT}(\Delta_i, \lambda_o) = 2^{-n} \sum_{\Delta_m} \sum_{\lambda_m} \text{UDLCT}(\Delta_i, \Delta_m, \lambda_m) \cdot \text{LDLCT}(\Delta_m, \lambda_m, \lambda_o)$$

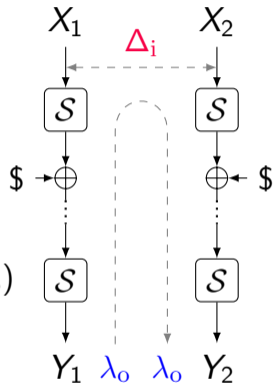

Generalized DLCT Framework (GBCT)

- How to formulate the correlation for more than 1 round?

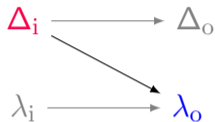

DLCT (Δ_i, λ_o)

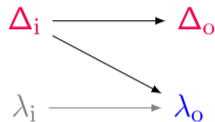

UDLCT ($\Delta_i, \Delta_o, \lambda_o$)

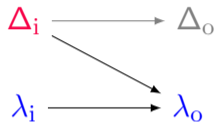

LDLCT ($\Delta_i, \lambda_i, \lambda_o$)

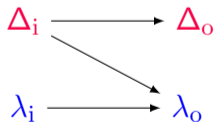

EDLCT ($\Delta_i, \Delta_o, \lambda_i, \lambda_o$)

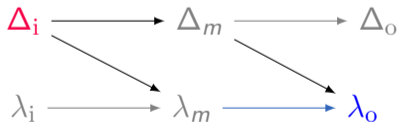

DDLCT (Δ_i, λ_o)

Application of the Generalized DLCT Tables - AES (- differential - linear)

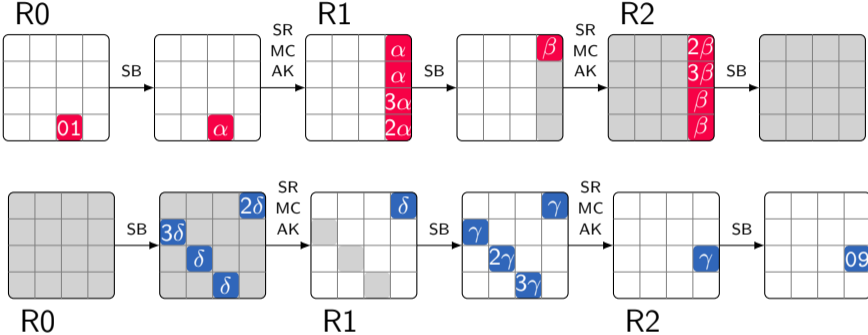

$$\sum_{\alpha, \beta, \gamma, \delta} \mathbb{C}_{UDLCT}(1, \alpha, \delta) \cdot \mathbb{C}_{EDLCT}(\alpha, \beta, \delta, \gamma) \cdot \mathbb{C}_{LDLCT}(\beta, \gamma, 9) = -2^{-7.94}$$

Application of the Generalized DLCT Tables - TWINE (- differential - linear)

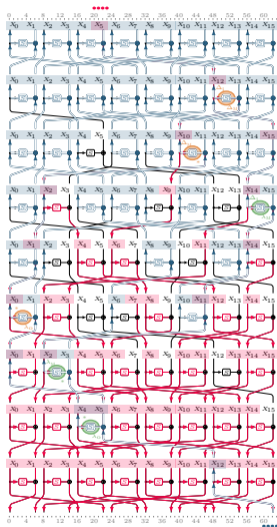

$$\begin{aligned} \mathbb{C}(\Delta_i, \lambda_o) &= \sum_{\Delta_m} \mathbb{P}_{\text{DDT}}(\Delta_i, \Delta_m) \cdot \mathbb{C}_{\text{DDLCT}}(\Delta_m, \lambda_o) \\ &= \sum_{\lambda_m} \mathbb{C}_{\text{DDLCT}}(\Delta_i, \lambda_m) \cdot \mathbb{C}_{\text{LAT}}^2(\lambda_m, \lambda_o). \end{aligned}$$

$$\mathbb{C}_{\text{tot}}(\Delta_i, \lambda_o) = \mathbb{C}^2(\Delta_i, \lambda_o).$$

| Input/Output Differences/Linear-mask | Formula | Exp. Correlation |
|--|--------------|------------------|
| $(\Delta_i, \lambda_o) = (0xb4, 0x67)$ | $-2^{-7.66}$ | $-2^{-7.64}$ |
| $(\Delta_i, \lambda_o) = (0x02, 0x02)$ | $-2^{-7.92}$ | $-2^{-7.93}$ |
| $(\Delta_i, \lambda_o) = (0x55, 0x55)$ | $-2^{-7.99}$ | $-2^{-7.98}$ |
| $(\Delta_i, \lambda_o) = (0xbf, 0xef)$ | $-2^{-8.05}$ | $-2^{-8.06}$ |
| $(\Delta_i, \lambda_o) = (0xfe, 0x06)$ | $-2^{-8.26}$ | $-2^{-8.25}$ |
| $(\Delta_i, \lambda_o) = (0x4b, 0x1a)$ | $-2^{-8.43}$ | $-2^{-8.44}$ |

Differential-Linear Switches and Deterministic Trails



Cell-Wise and Bit-Wise Switches

| | | | | | | | | | | | | | | | | |
|--------|---|---|---|---|---|---|---|---|---|---|---|---|---|---|---|---|
| x | 0 | 1 | 2 | 3 | 4 | 5 | 6 | 7 | 8 | 9 | a | b | c | d | e | f |
| $S(x)$ | 4 | 0 | a | 7 | b | e | 1 | d | 9 | f | 6 | 8 | 5 | 2 | c | 3 |

| $\Delta \setminus \lambda$ | 0 | 1 | 2 | 3 | 4 | 5 | 6 | 7 | 8 | 9 | a | b | c | d | e | f |
|----------------------------|----|----|----|----|-----|----|----|----|-----|----|----|----|-----|----|----|----|
| 0 | 16 | 16 | 16 | 16 | 16 | 16 | 16 | 16 | 16 | 16 | 16 | 16 | 16 | 16 | 16 | 16 |
| 1 | 16 | 0 | 0 | 0 | -16 | 0 | 0 | 0 | 0 | 0 | 0 | 0 | 0 | 0 | 0 | 0 |
| 2 | 16 | -8 | -8 | 0 | 0 | 0 | 8 | -8 | 0 | -8 | 0 | 8 | 0 | 0 | 0 | 0 |
| 3 | 16 | 0 | -8 | -8 | 0 | -8 | 8 | 0 | 0 | 0 | 0 | 0 | 0 | -8 | 0 | 8 |
| 4 | 16 | 0 | -8 | 0 | 0 | 0 | -8 | 0 | -16 | 0 | 8 | 0 | 0 | 0 | 8 | 0 |
| 5 | 16 | 0 | -8 | 0 | 0 | 0 | -8 | 0 | 0 | 0 | 8 | 0 | -16 | 0 | 8 | 0 |
| 6 | 16 | -8 | 8 | -8 | 0 | 0 | -8 | 0 | 0 | -8 | 0 | 0 | 0 | 0 | 0 | 8 |
| 7 | 16 | 0 | 8 | 0 | 0 | -8 | -8 | -8 | 0 | 0 | 0 | 8 | 0 | -8 | 0 | 0 |
| 8 | 16 | 0 | 0 | 0 | -16 | 0 | 0 | 0 | -16 | 0 | 0 | 0 | 16 | 0 | 0 | 0 |
| 9 | 16 | -8 | 0 | -8 | 16 | -8 | 0 | -8 | 0 | 8 | 0 | -8 | 0 | 8 | 0 | -8 |
| a | 16 | 0 | 0 | 8 | 0 | 8 | 0 | 0 | 0 | 0 | -8 | 0 | 0 | -8 | -8 | -8 |
| b | 16 | 8 | 0 | 0 | 0 | 0 | 0 | 8 | 0 | -8 | -8 | -8 | 0 | 0 | -8 | 0 |
| c | 16 | 0 | 0 | -8 | 0 | 0 | 0 | -8 | 16 | 0 | 0 | -8 | 0 | 0 | 0 | -8 |
| d | 16 | -8 | 0 | 0 | 0 | -8 | 0 | 0 | 0 | 8 | 0 | 0 | -16 | 8 | 0 | 0 |
| e | 16 | 0 | 0 | 0 | 0 | 8 | 0 | 8 | 0 | 0 | -8 | -8 | 0 | -8 | -8 | 0 |
| f | 16 | 8 | 0 | 8 | 0 | 0 | 0 | 0 | 0 | -8 | -8 | 0 | 0 | 0 | -8 | -8 |

- Cell-wise switches:
 $DLCT(\Delta_i, 0) = DLCT(0, \lambda_o) = 2^n$ for all Δ_i, λ_o
- Bit-wise switches:
 $DLCT(\Delta_i, \lambda_o) = \pm 2^n$ for $\Delta_i, \lambda_o \neq 0$
 - Example: $\mathbb{C}(9, 4) = \frac{16}{16}$

Deterministic Bit-Wise Differential Trails (Forward)

| | | | | | | | | | | | | | | | | |
|------|---|---|---|---|---|---|---|---|---|---|---|---|---|---|---|---|
| x | 0 | 1 | 2 | 3 | 4 | 5 | 6 | 7 | 8 | 9 | a | b | c | d | e | f |
| S(x) | 4 | 0 | a | 7 | b | e | 1 | d | 9 | f | 6 | 8 | 5 | 2 | c | 3 |

| $\Delta_i \setminus \Delta_o$ | 0 | 1 | 2 | 3 | 4 | 5 | 6 | 7 | 8 | 9 | a | b | c | d | e | f |
|-------------------------------|----|---|---|---|---|---|---|---|---|---|---|---|---|---|---|---|
| 0 | 16 | 0 | 0 | 0 | 0 | 0 | 0 | 0 | 0 | 0 | 0 | 0 | 0 | 0 | 0 | 0 |
| 1 | 0 | 0 | 0 | 0 | 2 | 2 | 2 | 2 | 0 | 0 | 0 | 0 | 2 | 2 | 2 | 2 |
| 2 | 0 | 2 | 0 | 2 | 0 | 0 | 0 | 4 | 0 | 2 | 2 | 0 | 0 | 0 | 2 | 2 |
| 3 | 0 | 2 | 0 | 2 | 0 | 0 | 4 | 0 | 0 | 2 | 2 | 0 | 0 | 0 | 2 | 2 |
| 4 | 0 | 0 | 0 | 0 | 0 | 0 | 0 | 0 | 0 | 0 | 4 | 4 | 2 | 2 | 2 | 2 |
| 5 | 0 | 0 | 0 | 0 | 2 | 2 | 2 | 2 | 0 | 0 | 4 | 4 | 0 | 0 | 0 | 0 |
| 6 | 0 | 2 | 0 | 2 | 0 | 4 | 0 | 0 | 0 | 2 | 2 | 0 | 2 | 2 | 0 | 0 |
| 7 | 0 | 2 | 0 | 2 | 4 | 0 | 0 | 0 | 0 | 2 | 2 | 0 | 2 | 2 | 0 | 0 |
| 8 | 0 | 0 | 0 | 0 | 0 | 0 | 0 | 0 | 0 | 0 | 0 | 0 | 4 | 4 | 4 | 4 |
| 9 | 0 | 4 | 4 | 0 | 0 | 0 | 0 | 0 | 0 | 4 | 0 | 4 | 0 | 0 | 0 | 0 |
| a | 0 | 0 | 2 | 2 | 2 | 0 | 0 | 2 | 4 | 0 | 0 | 0 | 0 | 2 | 0 | 2 |
| b | 0 | 0 | 2 | 2 | 0 | 2 | 2 | 0 | 4 | 0 | 0 | 0 | 2 | 0 | 2 | 0 |
| c | 0 | 4 | 4 | 0 | 2 | 2 | 2 | 2 | 0 | 0 | 0 | 0 | 0 | 0 | 0 | 0 |
| d | 0 | 0 | 0 | 0 | 2 | 2 | 2 | 2 | 0 | 4 | 0 | 4 | 0 | 0 | 0 | 0 |
| e | 0 | 0 | 2 | 2 | 0 | 2 | 2 | 0 | 4 | 0 | 0 | 0 | 0 | 2 | 0 | 2 |
| f | 0 | 0 | 2 | 2 | 2 | 0 | 0 | 2 | 4 | 0 | 0 | 0 | 2 | 0 | 2 | 0 |

$$\Delta_i = (0, 0, 0, 0) \xrightarrow{S} \Delta_o = (0, 0, 0, 0)$$

$$\Delta_i = (0, 0, 0, 1) \xrightarrow{S} \Delta_o = (?, 1, ?, ?)$$

$$\Delta_i = (0, 1, 0, 0) \xrightarrow{S} \Delta_o = (1, ?, ?, ?)$$

$$\Delta_i = (1, 0, 0, 0) \xrightarrow{S} \Delta_o = (1, 1, ?, ?)$$

$$\Delta_i = (1, 0, 0, 1) \xrightarrow{S} \Delta_o = (?, 0, ?, ?)$$

$$\Delta_i = (1, 1, 0, 0) \xrightarrow{S} \Delta_o = (0, ?, ?, ?)$$

Deterministic Bit-Wise Linear Trails (Backward)

| | | | | | | | | | | | | | | | | |
|--------|---|---|---|---|---|---|---|---|---|---|---|---|---|---|---|---|
| x | 0 | 1 | 2 | 3 | 4 | 5 | 6 | 7 | 8 | 9 | a | b | c | d | e | f |
| $S(x)$ | 4 | 0 | a | 7 | b | e | 1 | d | 9 | f | 6 | 8 | 5 | 2 | c | 3 |

| $\lambda_i \setminus \lambda_o$ | 0 | 1 | 2 | 3 | 4 | 5 | 6 | 7 | 8 | 9 | a | b | c | d | e | f |
|---------------------------------|----|----|----|----|----|----|----|----|----|----|----|----|----|----|----|----|
| 0 | 16 | 0 | 0 | 0 | 0 | 0 | 0 | 0 | 0 | 0 | 0 | 0 | 0 | 0 | 0 | 0 |
| 1 | 0 | 0 | 4 | -4 | 0 | -8 | -4 | -4 | 0 | 0 | 4 | -4 | -8 | 0 | 4 | 4 |
| 2 | 0 | 0 | 0 | 0 | 0 | 0 | 0 | 0 | 0 | 8 | 8 | 0 | 0 | 8 | -8 | 0 |
| 3 | 0 | -8 | 4 | 4 | 0 | 0 | -4 | 4 | 0 | 0 | -4 | 4 | -8 | 0 | -4 | -4 |
| 4 | 0 | 4 | 0 | 4 | 0 | 4 | 8 | -4 | 0 | 4 | 0 | 4 | -8 | -4 | 0 | 4 |
| 5 | 0 | 4 | -4 | -8 | 0 | -4 | -4 | 0 | 0 | 4 | -4 | 8 | 0 | -4 | -4 | 0 |
| 6 | 0 | -4 | 8 | 4 | 0 | -4 | 0 | -4 | 0 | 4 | 0 | 4 | 8 | -4 | 0 | 4 |
| 7 | 0 | 4 | 4 | 0 | 0 | -4 | 4 | -8 | 0 | -4 | -4 | 0 | 0 | 4 | -4 | -8 |
| 8 | 0 | 0 | 0 | 0 | 0 | 0 | 0 | 0 | 0 | 0 | 8 | 8 | 0 | 0 | 8 | -8 |
| 9 | 0 | 0 | -4 | 4 | 8 | 0 | -4 | -4 | 0 | 0 | 4 | -4 | 0 | -8 | -4 | -4 |
| a | 0 | 8 | 0 | 8 | 0 | -8 | 0 | 8 | 0 | 0 | 0 | 0 | 0 | 0 | 0 | 0 |
| b | 0 | 0 | -4 | 4 | -8 | 0 | -4 | -4 | 0 | 8 | -4 | -4 | 0 | 0 | 4 | -4 |
| c | 0 | 4 | 0 | 4 | 0 | 4 | -8 | -4 | 8 | -4 | 0 | 4 | 0 | 4 | 0 | 4 |
| d | 0 | 4 | 4 | 0 | -8 | 4 | -4 | 0 | -8 | -4 | 4 | 0 | 0 | -4 | -4 | 0 |
| e | 0 | 4 | 8 | -4 | 0 | 4 | 0 | 4 | 8 | 4 | 0 | -4 | 0 | -4 | 0 | -4 |
| f | 0 | -4 | -4 | 0 | -8 | -4 | 4 | 0 | 8 | -4 | 4 | 0 | 0 | -4 | -4 | 0 |

$$\lambda_i = (1, ?, ?, 1) \stackrel{S}{\leftarrow} \lambda_o = (0, 1, 0, 0)$$

$$\lambda_i = (1, 1, ?, ?) \stackrel{S}{\leftarrow} \lambda_o = (1, 0, 0, 0)$$

$$\lambda_i = (0, ?, ?, ?) \stackrel{S}{\leftarrow} \lambda_o = (1, 1, 0, 0)$$

Bit-Wise Switches and Deterministic Trails

| | | | | | | | | | | | | | | | | |
|--------|---|---|---|---|---|---|---|---|---|---|---|---|---|---|---|---|
| x | 0 | 1 | 2 | 3 | 4 | 5 | 6 | 7 | 8 | 9 | a | b | c | d | e | f |
| $S(x)$ | 4 | 0 | a | 7 | b | e | 1 | d | 9 | f | 6 | 8 | 5 | 2 | c | 3 |

| $\Delta \setminus \lambda$ | 0 | 1 | 2 | 3 | 4 | 5 | 6 | 7 | 8 | 9 | a | b | c | d | e | f |
|----------------------------|----|----|----|----|-----|----|----|----|-----|----|----|----|-----|----|----|----|
| 0 | 16 | 16 | 16 | 16 | 16 | 16 | 16 | 16 | 16 | 16 | 16 | 16 | 16 | 16 | 16 | 16 |
| 1 | 16 | 0 | 0 | 0 | -16 | 0 | 0 | 0 | 0 | 0 | 0 | 0 | 0 | 0 | 0 | 0 |
| 2 | 16 | -8 | -8 | 0 | 0 | 0 | 8 | -8 | 0 | -8 | 0 | 8 | 0 | 0 | 0 | 0 |
| 3 | 16 | 0 | -8 | -8 | 0 | -8 | 8 | 0 | 0 | 0 | 0 | 0 | 0 | -8 | 0 | 8 |
| 4 | 16 | 0 | -8 | 0 | 0 | 0 | -8 | 0 | -16 | 0 | 8 | 0 | 0 | 0 | 8 | 0 |
| 5 | 16 | 0 | -8 | 0 | 0 | 0 | -8 | 0 | 0 | 0 | 8 | 0 | -16 | 0 | 8 | 0 |
| 6 | 16 | -8 | 8 | -8 | 0 | 0 | -8 | 0 | 0 | -8 | 0 | 0 | 0 | 0 | 0 | 8 |
| 7 | 16 | 0 | 8 | 0 | 0 | -8 | -8 | -8 | 0 | 0 | 0 | 8 | 0 | -8 | 0 | 0 |
| 8 | 16 | 0 | 0 | 0 | -16 | 0 | 0 | 0 | -16 | 0 | 0 | 0 | 16 | 0 | 0 | 0 |
| 9 | 16 | -8 | 0 | -8 | 16 | -8 | 0 | -8 | 0 | 8 | 0 | -8 | 0 | 8 | 0 | -8 |
| a | 16 | 0 | 0 | 8 | 0 | 8 | 0 | 0 | 0 | 0 | -8 | 0 | 0 | -8 | -8 | -8 |
| b | 16 | 8 | 0 | 0 | 0 | 0 | 0 | 8 | 0 | -8 | -8 | -8 | 0 | 0 | -8 | 0 |
| c | 16 | 0 | 0 | -8 | 0 | 0 | 0 | -8 | 16 | 0 | 0 | -8 | 0 | 0 | 0 | -8 |
| d | 16 | -8 | 0 | 0 | 0 | -8 | 0 | 0 | 0 | 8 | 0 | 0 | -16 | 8 | 0 | 0 |
| e | 16 | 0 | 0 | 0 | 0 | 8 | 0 | 8 | 0 | 0 | -8 | -8 | 0 | -8 | -8 | 0 |
| f | 16 | 8 | 0 | 8 | 0 | 0 | 0 | 0 | 0 | -8 | -8 | 0 | 0 | 0 | -8 | -8 |

$$\Delta_i = (0, 0, 0, 1) \xrightarrow{S} \Delta_o = (?, 1, ?, ?)$$

$$\Delta_i = (0, 1, 0, 0) \xrightarrow{S} \Delta_o = (1, ?, ?, ?)$$

$$\Delta_i = (1, 0, 0, 0) \xrightarrow{S} \Delta_o = (1, 1, ?, ?)$$

$$\Delta_i = (1, 0, 0, 1) \xrightarrow{S} \Delta_o = (?, 0, ?, ?)$$

$$\Delta_i = (1, 1, 0, 0) \xrightarrow{S} \Delta_o = (0, ?, ?, ?)$$

$$\lambda_i = (1, ?, ?, 1) \xleftarrow{S} \lambda_o = (0, 1, 0, 0)$$

$$\lambda_i = (1, 1, ?, ?) \xleftarrow{S} \lambda_o = (1, 0, 0, 0)$$

$$\lambda_i = (0, ?, ?, ?) \xleftarrow{S} \lambda_o = (1, 1, 0, 0)$$

Automatic Tools to Search for DL Distinguishers



Overview of Our Method to Search for Distinguishers

E

Overview of Our Method to Search for Distinguishers

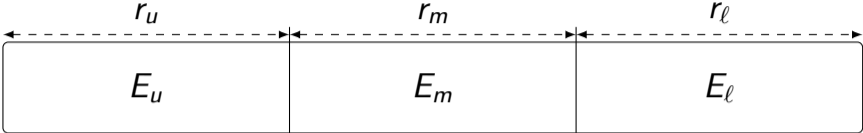

Overview of Our Method to Search for Distinguishers

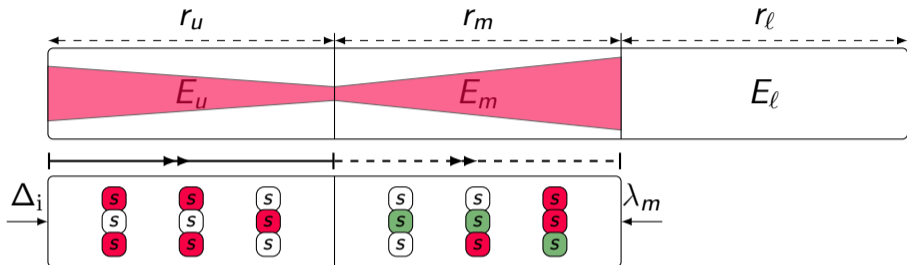

● differentially active S-box ● linearly active S-box ● common active S-box

Overview of Our Method to Search for Distinguishers

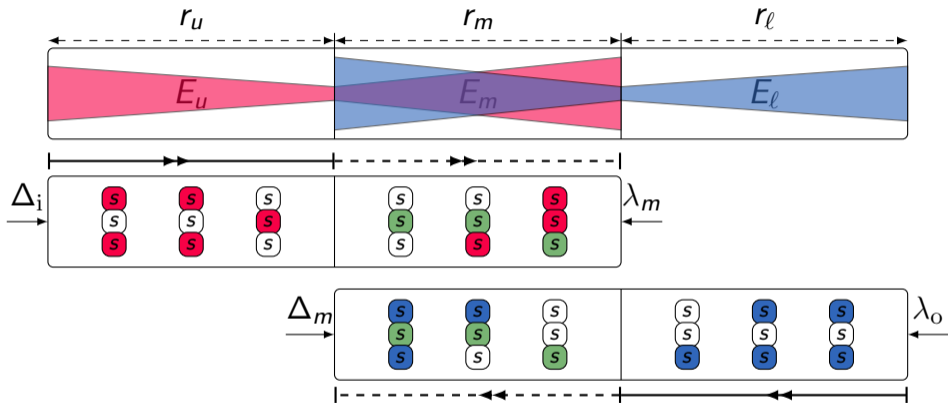

● differentially active S-box
 ● linearly active S-box
 ● common active S-box

Overview of Our Method to Search for Distinguishers

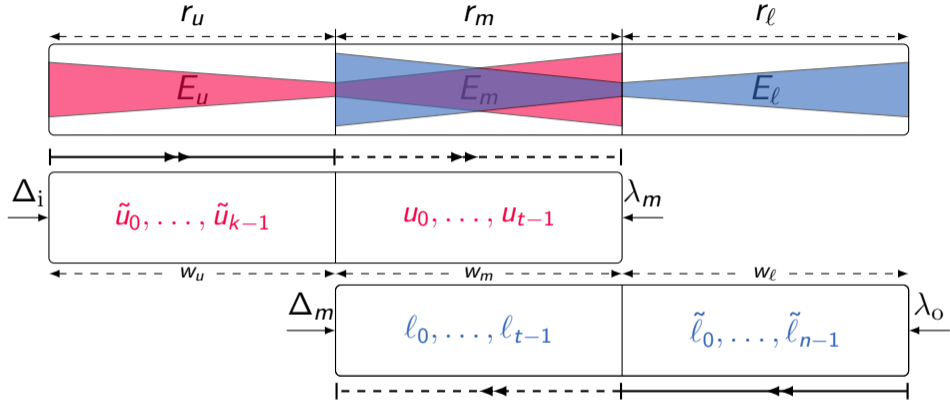

$$\min \left(\sum_{i=0}^{k-1} w_u \cdot \tilde{u}_i + \sum_{j=0}^{t-1} w_m \cdot \text{bool2int}(l_j + u_j = 2) + \sum_{k=0}^{n-1} w_l \cdot \tilde{l}_k \right)$$

Usage of Our Tool

```
python3 attack.py -RU 6 -RM 10 -RL 6
```

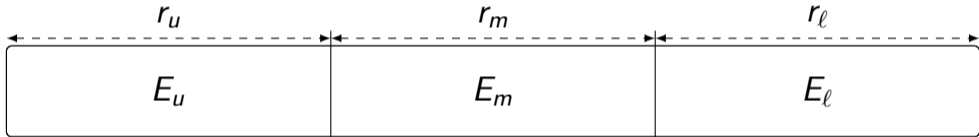

Results: A 5-round DL Distinguisher for AES

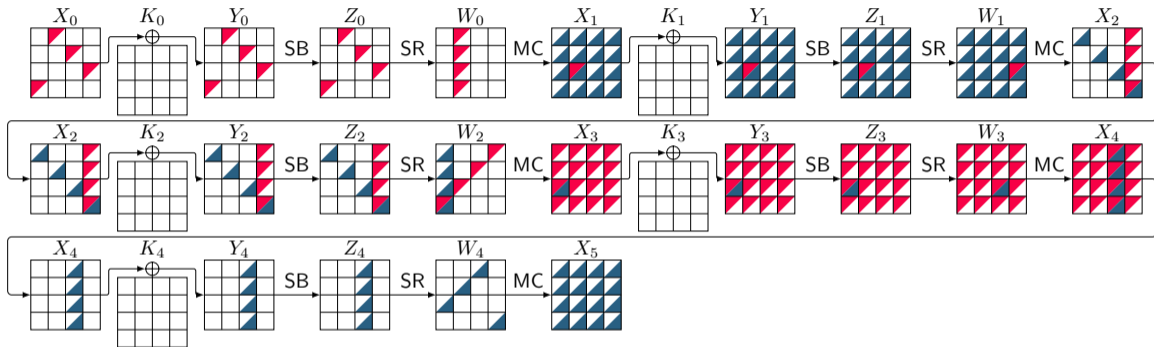

$$r_0 = 1, r_m = 3, r_1 = 1, p = 2^{-24.00}, r = 2^{-7.66}, q^2 = 2^{-24.00}, prq^2 = 2^{-55.66}$$

ΔX_0 001c00000000e200000000dfb3000000 ΔX_1 00000000000000000000f7000000000000
 ΓX_4 00000000000000000670000000000000 ΓX_5 21d3814d93b1ef228e923507f67383fd

Results: Application to Ascon-p (active difference unknown difference active mask unknown mask)

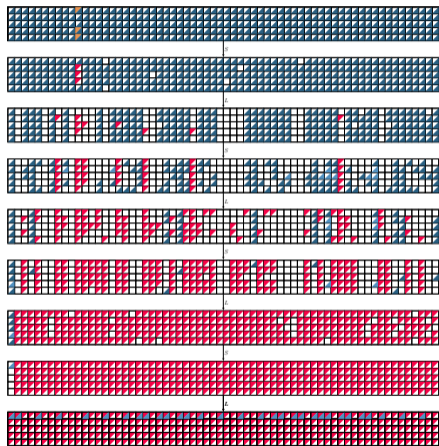

$C = 1$

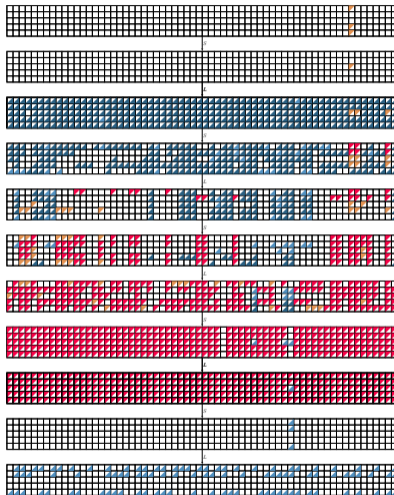

$C = 2^{-4.33}$

Contributions and Future Works



Contributions and Future Works

- Contributions

- ◆ We generalized the DLCT framework from one S-box layer to multiple rounds
- ◆ We proposed an automatic tool for finding optimum DL distinguishers
- ◆ We applied our tool to almost any design paradigm

- Future works

- A** Extending the application of our tool to other primitives, e.g., ARX
- A** Extending our tool to a unified model for finding complete attack (key recovery)

: <https://github.com/hadipourh/DL>

: <https://ia.cr/2024/255>

Bibliography I

- [Bar+19] Achiya Bar-On et al. **DLCT: A New Tool for Differential-Linear Cryptanalysis**. EUROCRYPT 2019. Vol. 11476. LNCS. Springer, 2019, pp. 313–342. DOI: [10.1007/978-3-030-17653-2_11](https://doi.org/10.1007/978-3-030-17653-2_11).
- [BLN14] Céline Blondeau, Gregor Leander, and Kaisa Nyberg. **Differential-Linear Cryptanalysis Revisited**. FSE 2014. Ed. by Carlos Cid and Christian Rechberger. Vol. 8540. LNCS. Springer, 2014, pp. 411–430. DOI: [10.1007/978-3-662-46706-0_21](https://doi.org/10.1007/978-3-662-46706-0_21).
- [Bou+20] Hamid Boukerrou et al. **On the Feistel Counterpart of the Boomerang Connectivity Table Introduction and Analysis of the FBCT**. *IACR Trans. Symmetric Cryptol.* 2020.1 (2020), pp. 331–362. DOI: [10.13154/TOSC.V2020.I1.331-362](https://doi.org/10.13154/TOSC.V2020.I1.331-362).

Bibliography II

- [BS90] Eli Biham and Adi Shamir. **Differential Cryptanalysis of DES-like Cryptosystems**. CRYPTO '90. Ed. by Alfred Menezes and Scott A. Vanstone. Vol. 537. LNCS. Springer, 1990, pp. 2–21. DOI: [10.1007/3-540-38424-3_1](https://doi.org/10.1007/3-540-38424-3_1).
- [Cid+18] Carlos Cid et al. **Boomerang Connectivity Table: A New Cryptanalysis Tool**. EUROCRYPT 2018. Ed. by Jesper Buus Nielsen and Vincent Rijmen. Vol. 10821. LNCS. Springer, 2018, pp. 683–714. DOI: [10.1007/978-3-319-78375-8_22](https://doi.org/10.1007/978-3-319-78375-8_22).
- [DDV20] Stéphanie Delaune, Patrick Derbez, and Mathieu Vavrille. **Catching the Fastest Boomerangs Application to SKINNY**. *IACR Trans. Symmetric Cryptol.* 2020.4 (2020), pp. 104–129. DOI: [10.46586/TOSC.V2020.I4.104-129](https://doi.org/10.46586/TOSC.V2020.I4.104-129).

Bibliography III

- [DIK08] Orr Dunkelman, Sebastiaan Indestege, and Nathan Keller. **A Differential-Linear Attack on 12-Round Serpent**. INDOCRYPT 2008. Ed. by Dipanwita Roy Chowdhury, Vincent Rijmen, and Abhijit Das. Vol. 5365. LNCS. Springer, 2008, pp. 308–321. DOI: [10.1007/978-3-540-89754-5_24](https://doi.org/10.1007/978-3-540-89754-5_24).
- [DKS10] Orr Dunkelman, Nathan Keller, and Adi Shamir. **A Practical-Time Related-Key Attack on the KASUMI Cryptosystem Used in GSM and 3G Telephony**. CRYPTO. Vol. 6223. LNCS. Springer, 2010, pp. 393–410. DOI: [10.1007/978-3-642-14623-7_21](https://doi.org/10.1007/978-3-642-14623-7_21).
- [DKS14] Orr Dunkelman, Nathan Keller, and Adi Shamir. **A Practical-Time Related-Key Attack on the KASUMI Cryptosystem Used in GSM and 3G Telephony**. *J. Cryptol.* 27.4 (2014), pp. 824–849. DOI: [10.1007/s00145-013-9154-9](https://doi.org/10.1007/s00145-013-9154-9).

Bibliography IV

- [HB21] Hosein Hadipour and Nasour Bagheri. **Improved Rectangle Attacks on SKINNY and CRAFT**. *IACR Trans. Symmetric Cryptol.* 2021.2 (2021), pp. 140–198. DOI: [10.46586/TOSC.V2021.I2.140-198](https://doi.org/10.46586/TOSC.V2021.I2.140-198).
- [HNE22] Hosein Hadipour, Marcel Nageler, and Maria Eichlseder. **Throwing Boomerangs into Feistel Structures Application to CLEFIA, WARP, LBlock, LBlock-s and TWINE**. *IACR Trans. Symmetric Cryptol.* 2022.3 (2022), pp. 271–302. DOI: [10.46586/TOSC.V2022.I3.271-302](https://doi.org/10.46586/TOSC.V2022.I3.271-302).
- [LH94] Susan K. Langford and Martin E. Hellman. **Differential-Linear Cryptanalysis**. CRYPTO '94. Vol. 839. Springer, 1994, pp. 17–25. DOI: [10.1007/3-540-48658-5_3](https://doi.org/10.1007/3-540-48658-5_3).

Bibliography V

- [Mat93] Mitsuru Matsui. **Linear Cryptanalysis Method for DES Cipher**. EUROCRYPT '93. Ed. by Tor Hellesest. Vol. 765. LNCS. Springer, 1993, pp. 386–397. DOI: [10.1007/3-540-48285-7_33](https://doi.org/10.1007/3-540-48285-7_33).
- [SQH19] Ling Song, Xianrui Qin, and Lei Hu. **Boomerang Connectivity Table Revisited. Application to SKINNY and AES**. *IACR Trans. Symmetric Cryptol.* 2019.1 (2019), pp. 118–141. DOI: [10.13154/TOSC.V2019.I1.118-141](https://doi.org/10.13154/TOSC.V2019.I1.118-141). URL: <https://doi.org/10.13154/tosc.v2019.i1.118-141>.
- [Wag99] David A. Wagner. **The Boomerang Attack**. FSE. Vol. 1636. LNCS. Springer, 1999, pp. 156–170. DOI: [10.1007/3-540-48519-8_12](https://doi.org/10.1007/3-540-48519-8_12).
- [WP19] Haoyang Wang and Thomas Peyrin. **Boomerang Switch in Multiple Rounds. Application to AES Variants and Deoxys**. *IACR Trans. Symmetric Cryptol.* 2019.1 (2019), pp. 142–169. DOI: [10.13154/TOSC.V2019.I1.142-169](https://doi.org/10.13154/TOSC.V2019.I1.142-169).

Bibliography VI

- [ZWH24] Yanyan Zhou, Senpeng Wang, and Bin Hu. **MILP/MIQCP-Based Fully Automatic Method of Searching for Differential-Linear Distinguishers for SIMON-Like Ciphers.** *IET Information Security* 2024 (2024). DOI: [10.1049/2024/8315115](https://doi.org/10.1049/2024/8315115).

Properties of Generalized DLCT Tables - I

- $DLCT(\Delta_i, \lambda_o) = \sum_{\Delta_o} UDLCT(\Delta_i, \Delta_o, \lambda_o)$
- $UDLCT(\Delta_i, \Delta_o, \lambda_o) = (-1)^{\Delta_o \cdot \lambda_o} DDT(\Delta_i, \Delta_o)$
- $LDLCT(\Delta_i, \lambda_i, \lambda_o) = (-1)^{\Delta_i \cdot \lambda_i} DLCT(\Delta_i, \lambda_o)$
- $EDLCT(\Delta_i, \Delta_o, \lambda_i, \lambda_o) = (-1)^{\lambda_i \cdot \Delta_i \oplus \lambda_o \cdot \Delta_o} DDT(\Delta_i, \Delta_o)$
- $LDLCT(\Delta_i, \lambda_i, \lambda_o) = \sum_{\Delta_o} EDLCT(\Delta_i, \Delta_o, \lambda_i, \lambda_o)$
- $\sum_{\Delta_i} LDLCT(\Delta_i, \lambda_i, \lambda_o) = LAT^2(\lambda_i, \lambda_o)$

Properties of Generalized DLCT Tables - II

- $$\text{DDLCT}(\Delta_i, \lambda_o) = 2^{-n} \cdot \sum_{\Delta_m} \sum_{\lambda_m} \text{UDLCT}(\Delta_i, \Delta_m, \lambda_m) \cdot \text{LDLCT}(\Delta_m, \lambda_m, \lambda_o)$$

$$\begin{aligned} \text{DDLCT}(\Delta_i, \lambda_o) &= \sum_{\Delta_m} \text{DDT}(\Delta_i, \Delta_m) \cdot \text{DLCT}(\Delta_m, \lambda_o) \\ &= 2^{-n} \sum_{\lambda_m} \text{DLCT}(\Delta_i, \lambda_m) \cdot \text{LAT}^2(\lambda_m, \lambda_o). \end{aligned}$$

Results: Distinguishers for up to 17 Rounds of TWINE

- Comparing the data complexity of best boomerang and DL distinguishers

| # Rounds | Boomerang [HNE22] | Differential-Linear | Gain |
|-----------|-------------------|---------------------|-------------|
| 5 | 1 | 1 | 1 |
| 7 | $2^{3.20}$ | 1 | $2^{3.20}$ |
| 13 | $2^{34.32}$ | $2^{27.16}$ | $2^{7.16}$ |
| 14 | $2^{42.25}$ | $2^{31.28}$ | $2^{10.97}$ |
| 15 | $2^{51.03}$ | $2^{38.98}$ | $2^{12.05}$ |
| 16 | $2^{58.04}$ | $2^{47.28}$ | $2^{10.76}$ |
| 17 | - | $2^{59.24}$ | - |

Results: Distinguishers for up to 17 Rounds of LBlock

- Comparing the data complexity of best boomerang and DL distinguishers

| # Rounds | Boomerang [HNE22] | Differential-Linear | Gain |
|-----------|-------------------|---------------------|-------------|
| 5 | 1 | 1 | 1 |
| 7 | $2^{2.97}$ | 1 | $2^{2.97}$ |
| 13 | $2^{30.28}$ | $2^{23.78}$ | $2^{6.50}$ |
| 14 | $2^{38.86}$ | $2^{30.34}$ | $2^{8.52}$ |
| 15 | $2^{46.90}$ | $2^{38.26}$ | $2^{8.64}$ |
| 16 | $2^{57.16}$ | $2^{46.26}$ | $2^{10.90}$ |
| 17 | - | $2^{58.30}$ | - |

Results: Distinguishers for up to 8 Rounds of CLEFIA

- Comparing the data complexity of best boomerang and DL distinguishers

| # Rounds | Boomerang [HNE22] | Differential-Linear | Gain |
|----------|-------------------|---------------------|------------|
| 3 | 1 | 1 | 1 |
| 4 | $2^{6.32}$ | 1 | $2^{6.32}$ |
| 5 | $2^{12.26}$ | $2^{5.36}$ | $2^{6.90}$ |
| 6 | $2^{22.45}$ | $2^{14.14}$ | $2^{8.31}$ |
| 7 | $2^{32.67}$ | $2^{23.50}$ | $2^{9.17}$ |
| 8 | $2^{76.03}$ | $2^{66.86}$ | $2^{9.17}$ |

Results: Application to SERPENT

- : Experimentally verified

| Cipher | #R | \mathbb{C} |  | Ref. |
|---------|----|--------------|---|-----------|
| SERPENT | 3 | $2^{-0.68}$ | ✓ | This work |
| | 4 | $2^{-12.75}$ | | [DIK08] |
| | 4 | $2^{-5.54}$ | ✓ | This work |
| | 5 | $2^{-16.75}$ | | [DIK08] |
| | 5 | $2^{-11.10}$ | ✓ | This work |
| | 8 | $2^{-39.18}$ | | This work |
| | 9 | $2^{-56.50}$ | | [DIK08] |
| | 9 | $2^{-50.95}$ | | This work |

Results: Application to Simeck

- : Experimentally verified

| Cipher | #R | C |  | Ref. |
|-----------|----|--------------------------------|---|-----------|
| | 7 | 1 | ✓ | This work |
| Simeck-32 | 14 | $2^{-16.63}$ | | [ZWH24] |
| | 14 | $2^{-13.92}$ | ✓ | This work |

| Cipher | #R | C |  | Ref. |
|-----------|-----------|--------------------------------|---|-----------|
| | 8 | 1 | ✓ | This work |
| | 17 | $2^{-22.37}$ | | [ZWH24] |
| | 17 | $2^{-13.89}$ | ✓ | This work |
| Simeck-48 | 18 | $2^{-24.75}$ | | [ZWH24] |
| | 18 | $2^{-15.89}$ | | This work |
| | 19 | $2^{-17.89}$ | | This work |
| | 20 | $2^{-21.89}$ | | This work |

| Cipher | #R | C |  | Ref. |
|-----------|-----------|--------------------------------|---|-----------|
| | 10 | 1 | ✓ | This work |
| | 24 | $2^{-38.13}$ | | [ZWH24] |
| Simeck-64 | 24 | $2^{-25.14}$ | | This work |
| | 25 | $2^{-41.04}$ | | [ZWH24] |
| | 25 | $2^{-27.14}$ | | This work |
| | 26 | $2^{-30.35}$ | | This work |